

Leather Wallet- Anthony

Name	Leather Wallet- Anthony
Style No.	ZnBSi
Division	AM 376 - SP2022
Season	SP2022
Year	2021-2022
Size Scale	<input checked="" type="checkbox"/> OS -Sample size
	<input type="checkbox"/> OS
AM 376 - Developer Name	Anthony Sena
Factory	To Be Determined
COO	China
Main Fabric	Leather
New/Carryover	New Style
Style Status	In Development
Sample Development Status	1st Sample
MSRP	50
MOQ	1000 perstyle/color
Leadtime	90
Created by/Author	05-09-2022 Anthony Sena Anthony.Sena-Chavez@colostate.edu

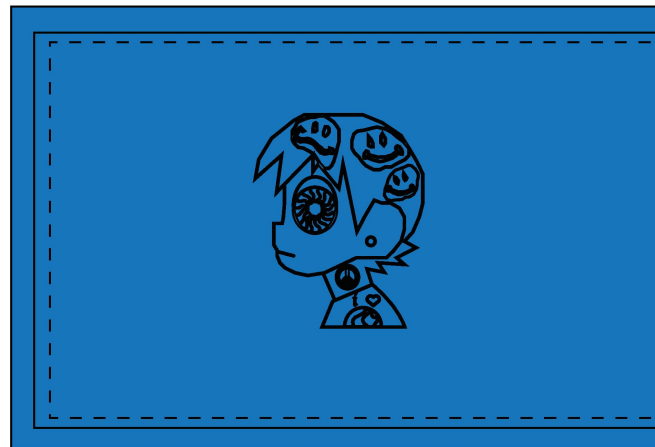

- Blue Aster- Anthony  
Custom Code: 18-4252 TCX- Anthony  
wallet wallet copy-4

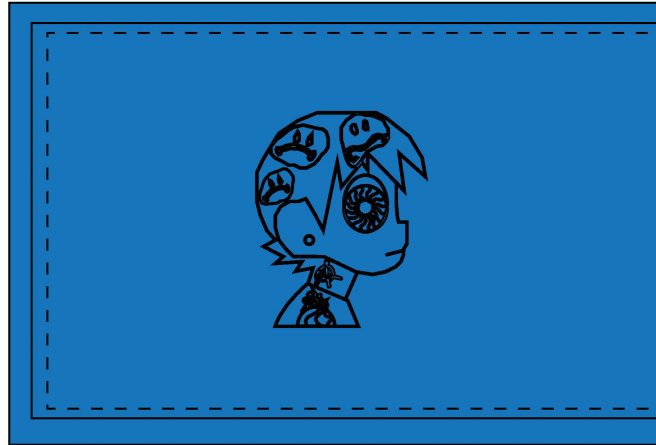
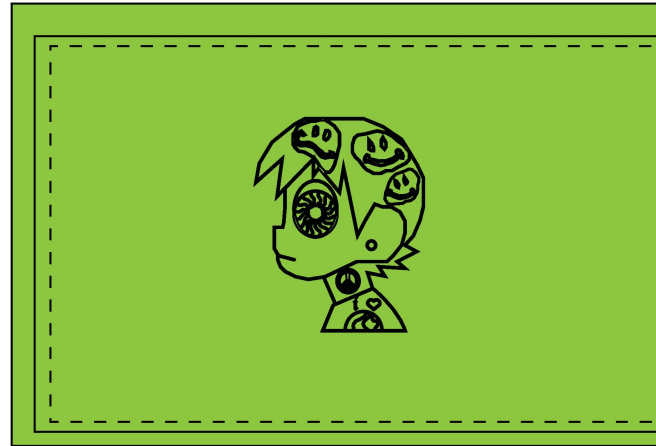
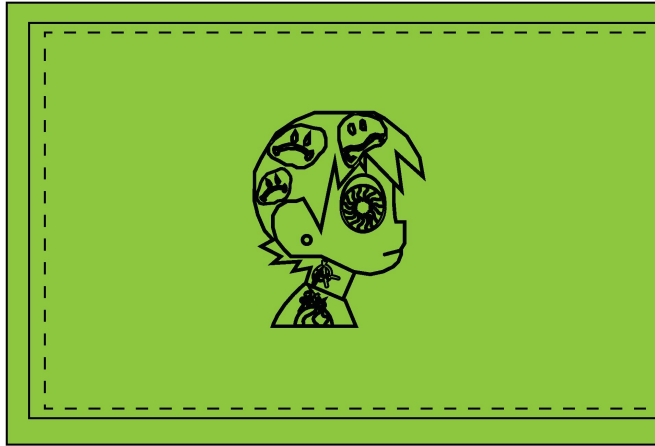

- Greenery- Anthony  
Custom Code: 15-0343 TCX- Anthony  
wallet wallet copy-5

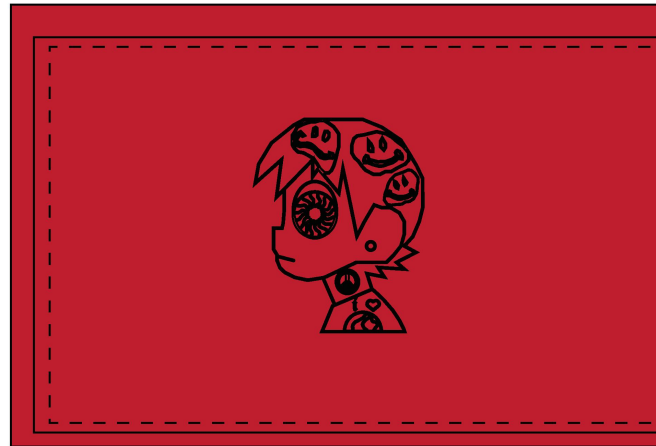
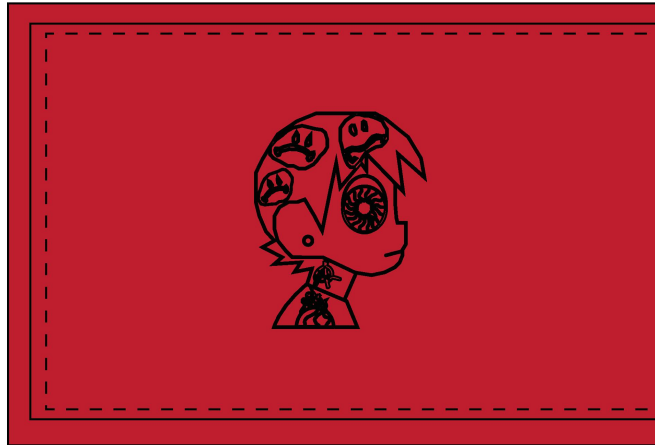

- Fiery Red- Anthony  
Custom Code: 18-1664 TCX- Anthony  
wallet wallet copy-6



Components (3)

- B1** Vegetable Tanned Leather
- B2** Polyester Waxed Thread- Anthony
- B3** Interior Tuscania Leather

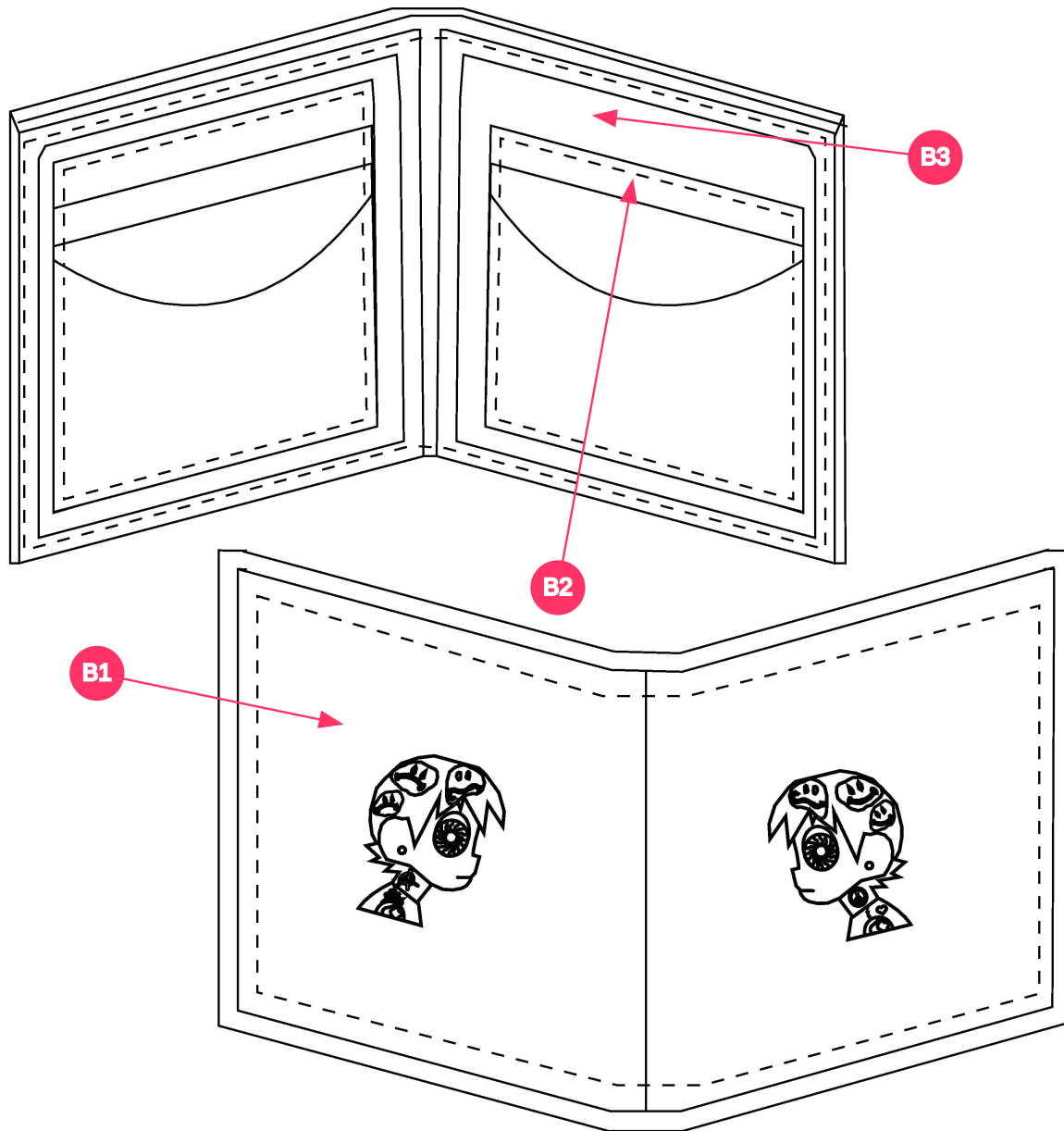

wallet wallet copy-2 (Copy)



Construction Details (2)

C1 205 Saddle Stitch

C2 205 Saddle Stitch

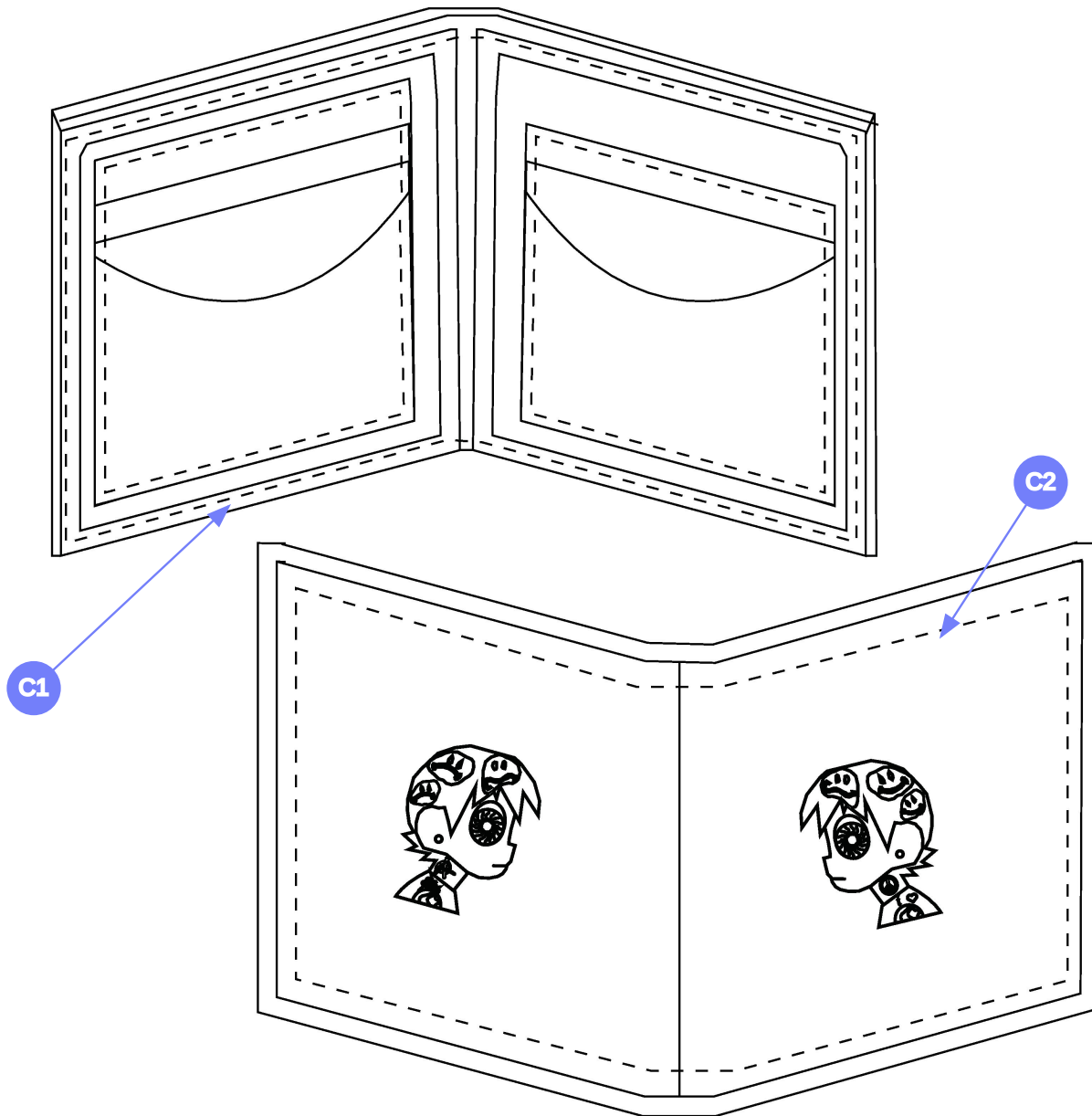

wallet wallet copy-2 (Copy)

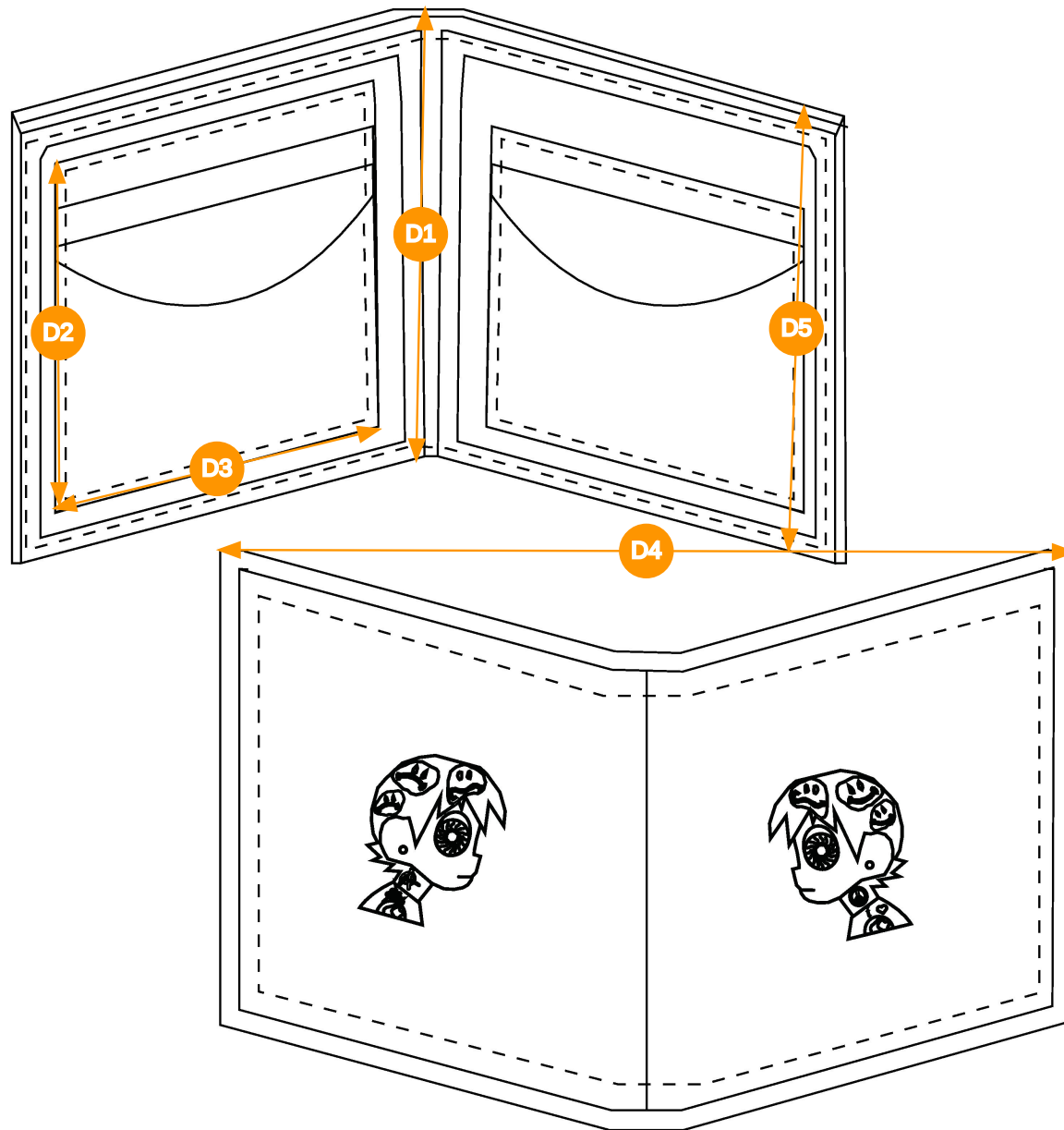

Points of measure (5)













- D1** Wallet Height
- D2** Wallet Pocket Heights
- D3** Wallet Pocket Widths
- D4** Wallet Width
- D5** Wallet Money Holder Pocket Depth

wallet wallet copy-2 (Copy)



# Leather Wallet- Anthony - Style #ZnBSi

AM 376 - SP2022, SP2022, 2021-2022





THUMBNAIL	COMPONENT	QTY	PLACEMENT	SUPPLIER	COO	BLUE ASTER-ANTHONY CODE: 18-4252 TCX- ANTHONY	GREENERY-ANTHONY CODE: 15-0343 TCX- ANTHONY	FIERY RED-ANTHONY CODE: 18-1664 TCX- ANTHONY
<b>MATERIALS</b>								
1	 <p><b>Interior Tuscania Leather</b> CODE: hJL47 Status : In Development Content (Fiber Content): 100% Leather Fabric Width: 48" Weight (GSM): 3.5 Finishes: N/A Dye Method: Piece Dyed Size: N/a AM 376 - Developer Name: Anthony Sena</p>	1 /yd	Interior Lining and Interior Card Holder Pockets	To Be Determined	USA	 Blue Aster-Anthony Custom Code: 18-4252 TCX-Anthony Price: \$12.00	 Greenery-Anthony Custom Code: 15-0343 TCX-Anthony Price: \$12.00	 Fiery Red-Anthony Custom Code: 18-1664 TCX-Anthony Price: \$12.00
2	 <p><b>Vegetable Tanned Leather</b> CODE: Jyfqc Status : In Development Content (Fiber Content): 100% Leather Fabric Width: 48" Weight (GSM): 5 Finishes: N/A AM 376 - Developer Name: Anthony Sena</p>	1 /yd	Exterior of Wallet	To Be Determined	USA	 Blue Aster-Anthony Custom Code: 18-4252 TCX-Anthony Price: \$12.50	 Fiery Red-Anthony Custom Code: 18-1664 TCX-Anthony Price: \$12.50	 Greenery-Anthony Custom Code: 15-0343 TCX-Anthony Price: \$12.50
<b>TRIMS</b>								
3	 <p><b>Polyester Waxed Thread- Anthony</b> CODE: a8Aud Status : In Development Content (Fiber Content): 100% Polyester Fabric Width: 51" Weight (GSM): 120 Finishes: N/A Dye Method: N/A Size: N/A AM 376 - Developer Name: Anthony Sena</p>	1 /Pieces	Throughout Wallet	To Be Determined	China	 Black 3 C-Anthony Custom Code: Black 3 C-Anthony Price: \$0.33	 Black 3 C-Anthony Custom Code: Black 3 C-Anthony Price: \$0.33	 Black 3 C-Anthony Custom Code: Black 3 C-Anthony Price: \$0.33
<b>PACKAGING</b>								



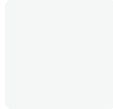
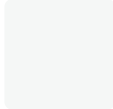

# Leather Wallet- Anthony - Style #ZnBSi

AM 376 - SP2022, SP2022, 2021-2022

THUMBNAIL	COMPONENT	QTY	PLACEMENT	SUPPLIER	COO	<span style="color: blue;">●</span> <b>BLUE ASTER-ANTHONY</b> <small>CODE: 18-4252 TCX- ANTHONY</small>	<span style="color: green;">●</span> <b>GREENERY-ANTHONY</b> <small>CODE: 15-0343 TCX- ANTHONY</small>	<span style="color: red;">●</span> <b>FIERY RED-ANTHONY</b> <small>CODE: 18-1664 TCX- ANTHONY</small>
4	 <p><b>Custom Embossed Hangtag</b>            CODE: gKjr0            Status : In Development Content (Fiber Content): Paper Weight (GSM): 0.002 Finishes: N/A Dye Method: N/A Size: N/A AM 376 - Developer Name: Anthony Sena</p>	1 /Pieces	Attached to Top Right Corner of Wallet	To Be Determined	China	-	-	-
						 <b>Bright White-Anthony</b> <small>Custom Code: 11-0601 TPG-Anthony</small> Price: \$0.15	 <b>Bright White-Anthony</b> <small>Custom Code: 11-0601 TPG-Anthony</small> Price: \$0.15	 <b>Bright White-Anthony</b> <small>Custom Code: 11-0601 TPG-Anthony</small> Price: \$0.15
5	 <p><b>Packaging Box</b>            CODE: 2563            Status : In Development Content (Fiber Content): Cardboard Finishes: N/A Dye Method: N/A Size: N/A AM 376 - Developer Name: Anthony Sena</p>	1 /Pieces	N/A	To Be Determined	China	-	-	-
						 <b>Black 3 C-Anthony</b> <small>Custom Code: Black 3 C-Anthony</small> Price: \$0.53	 <b>Black 3 C-Anthony</b> <small>Custom Code: Black 3 C-Anthony</small> Price: \$0.53	 <b>Black 3 C-Anthony</b> <small>Custom Code: Black 3 C-Anthony</small> Price: \$0.53
Components <b>5</b>						Total <b>\$25.51</b>	Total <b>\$25.51</b>	Total <b>\$25.51</b>



**Sample Size: OS**

POINT OF MEASURE	CODE	HOW TO MEASURE	CRITICAL	TYPE	TOLERANCE	OS
Wallet Width	989632	Lay wallet flat and measure edge to edge from top	true	Full	1/4 in	9 in
Wallet Height	488965	Lay wallet flat and measure from top right edge to bottom left edge	true	Full	1/4 in	3 1/2 in
Wallet Pocket Heights	44298442	Lay wallet flat and measure from top right corner pocket edge to bottom right corner pocket edge( multiple pockets so apply same concept)	true	Full	1/4 in	3 in
Wallet Pocket Widths	779912	Lay wallet flat and measure from edge to edge from top of pocket (multiple pockets so apply same concept)	true	Full	1/4 in	4 in
Wallet Money Holder Pocket Depth	292742	Lay wallet flat and measure from top center point of wallet to bottom center point of wallet	true	Full	1/4 in	3 1/2 in



**Sample Size: OS**

POINT OF MEASURE	CODE	HOW TO MEASURE	CRITICAL	TYPE	TOLERANCE	OS
Wallet Width	989632	Lay wallet flat and measure edge to edge from top	true	Full	1/4 in	9 in
Wallet Height	488965	Lay wallet flat and measure from top right edge to bottom left edge	true	Full	1/4 in	3 1/2 in
Wallet Pocket Heights	44298442	Lay wallet flat and measure from top right corner pocket edge to bottom right corner pocket edge( multiple pockets so apply same concept)	true	Full	1/4 in	3 in
Wallet Pocket Widths	779912	Lay wallet flat and measure from edge to edge from top of pocket (multiple pockets so apply same concept)	true	Full	1/4 in	4 in
Wallet Money Holder Pocket Depth	292742	Lay wallet flat and measure from top center point of wallet to bottom center point of wallet	true	Full	1/4 in	3 1/2 in