



**Tote Bag - Anthony**

Name	Tote Bag - Anthony
Style No.	1712
Description	Tote bag that has two zippered pockets, along with a zipper closure
Division	AM 376 - SP2022
Season	SP2022
Year	2021-2022
Size Scale	<input checked="" type="checkbox"/> OS -Sample size <input type="checkbox"/> OS
AM 376 - Developer Name	Anthony Sena-Chavez
Factory	To Be Determined
COO	China
Main Fabric	100% Canvas
New/Carryover	New Style
Style Status	In Development
Sample Development Status	1st Sample
MSRP	60
MOQ	100 pc/style/color
Leadtime	90 Days
Created by/Author	05-09-2022 Anthony Sena Anthony.Sena-Chavez@colostate.edu



- Abundant Green- Anthony  
Custom Code: 18-6026 TPG  
Tote bag Ff-4



- Bombay Brown- Anthony  
Custom Code: 18-1250 TCX  
Tote bag Ff-6



● Maroon- Anthony..  
Custom Code: 18-1619 TPG  
Tote bag Ff-5



Components (5)

- B1** 100% Polyester Zipper- Anthony
- B2** 100% Polyester Thread \_
- B3** 100% Cotton Duckcloth Fabric- Anthony
- B4** 100% Novelty Cotton Camo Fabric
- B5** 100% Polyester Zipper- Anthony

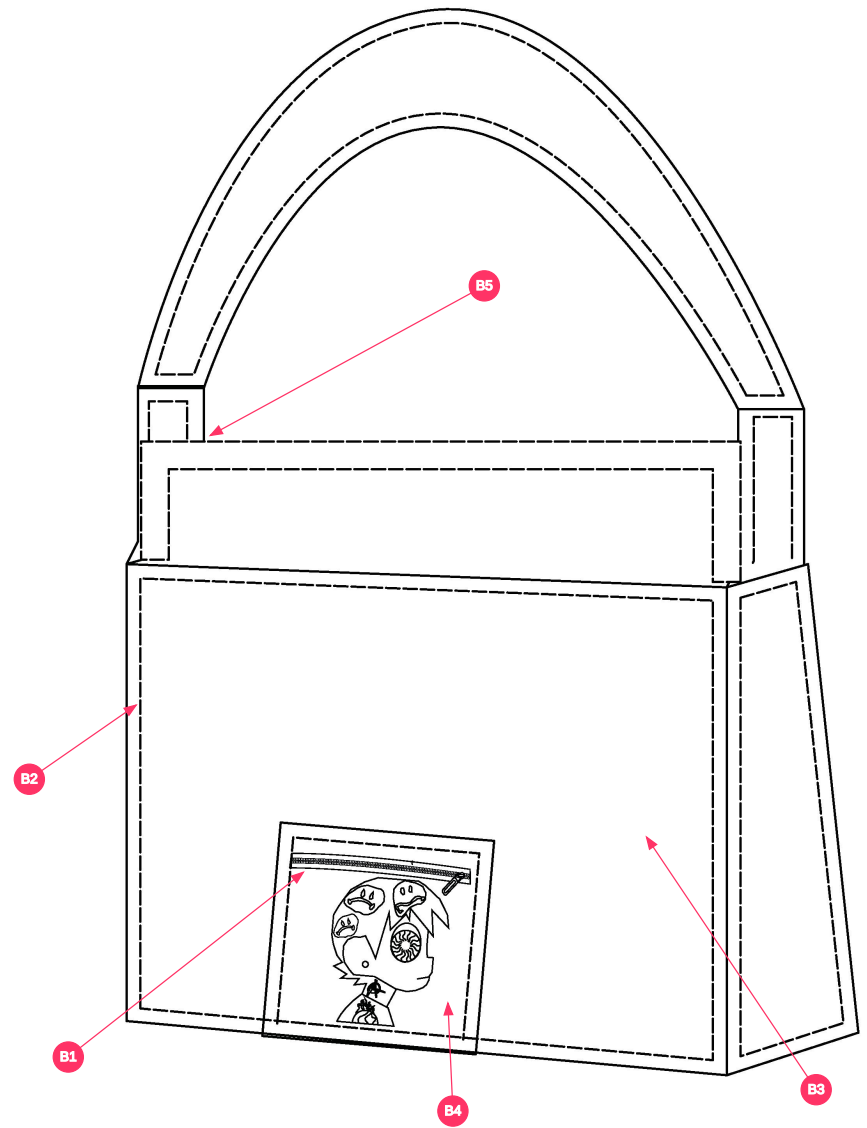

Tote bag Ff-2 (Copy)



Construction Details (5)

- C1 1/8" 1 NDL TOP ST
- C2 1/8" 1 NDL TOP ST
- C3 1/8" 1 NDL TOP ST
- C4 1/8" 1 NDL TOP ST
- C5 1/8" 1 NDL TOP ST

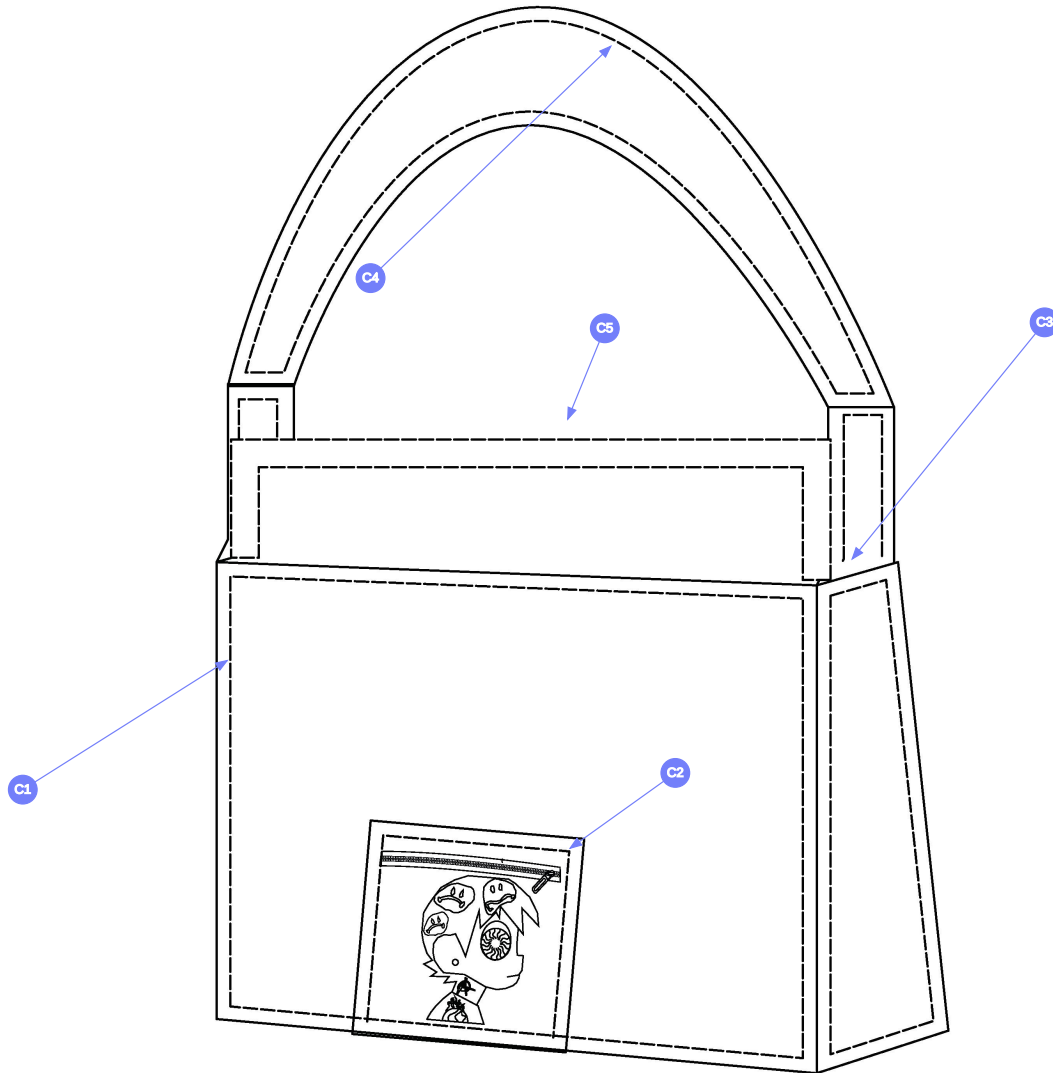

Tote bag Ff-2 (Copy)



Points of measure (8)

- D1** Bag Width
- D2** Bag Length
- D3** Bag Depth
- D4** Zipper Pocket Width
- D5** Zipper Pocket Length
- D6** Zipper Pocket Depth
- D7** Strap Width
- D8** Strap Length

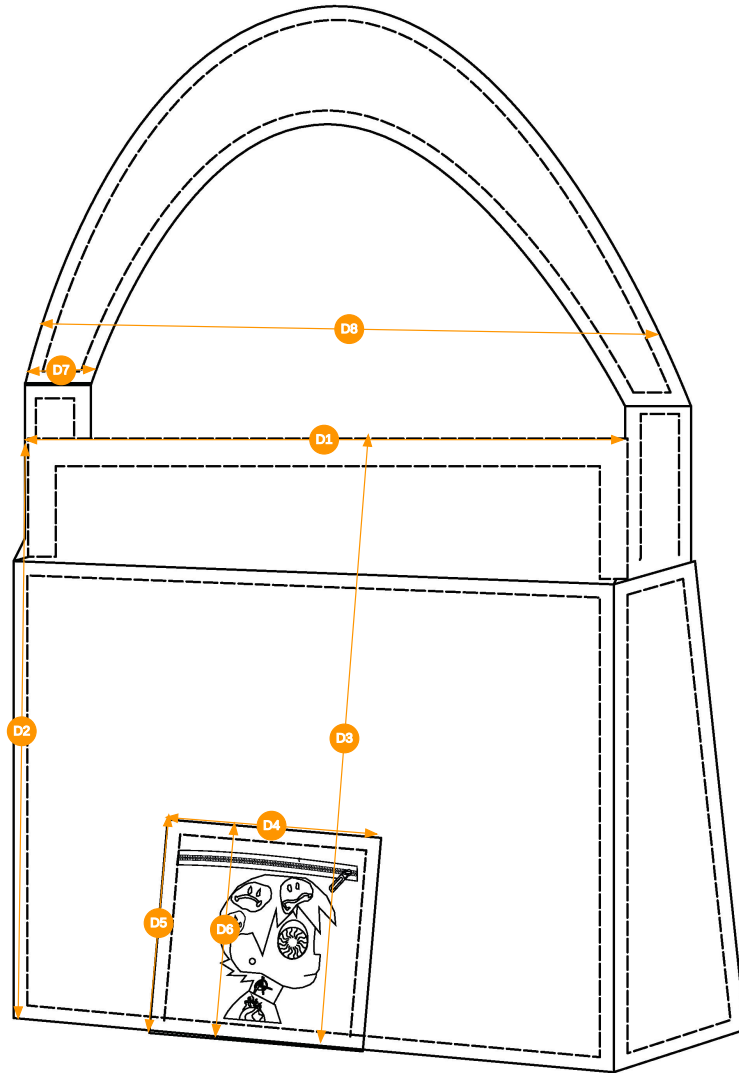









Tote bag Ff-2 (Copy)



# Tote Bag - Anthony - Style #1712

AM 376 - SP2022, SP2022, 2021-2022

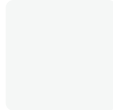
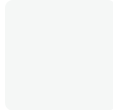
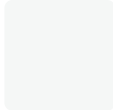







THUMBNAIL	COMPONENT	QTY	PLACEMENT	SUPPLIER	COO	ABUNDANT GREEN-ANTHONY CODE: 18-6026 TPG	BOMBAY BROWN-ANTHONY CODE: 18-1250 TCX	MAROON-ANTHONY.. CODE: 18-1619 TPG
<b>MATERIALS</b>								
1	 <p><b>100% Cotton Duckcloth Fabric- Anthony</b> CODE: ijere Status : In Development Content (Fiber Content): 100% Cotton Fabric Width: 51" Finishes: N/A Dye Method: N/A Size: N/A AM 376 - Developer Name: Anthony Sena-Chavez</p>	1 /yd	Exterior of Bag and Exterior of Straps	To Be Determined	China	 Abundant Green-Anthony Custom Code: 18-6026 TPG Price: \$7.00	 Bombay Brown-Anthony Custom Code: 18-1250 TCX Price: \$7.00	 Maroon-Anthony Custom Code: 18-1619 TCX Price: \$7.00
2	 <p><b>100% Polyester Interlining Fabric - Anthony</b> CODE: erfke Status : In Development Content (Fiber Content): 100% Polyester Fabric Width: 58" Finishes: N/A Dye Method: N/A Size: N/A AM 376 - Developer Name: Anthony Sena-Chavez</p>	1 /yd	Interior of Bag and Interior of Straps	To Be Determined	China	 Black-Anthony Custom Code: Black 3 C Price: \$6.00	 Black-Anthony Custom Code: Black 3 C Price: \$6.00	 Black-Anthony Custom Code: Black 3 C Price: \$6.00
3	 <p><b>100% Novelty Cotton Camo Fabric</b> CODE: 223 Status : In Development Content (Fiber Content): 100% Novelty Cotton Fabric Width: 48" Finishes: N/A Dye Method: Piece Dyed Size: N/A AM 376 - Developer Name: Anthony Sena-Chavez</p>	1 /yd	Used as Zipper Pockets color blocking	To Be Determined	China	 Bright White pantone Custom Code: 11-0601 TPG-Anthony Price: \$8.24	 Bright White pantone Custom Code: 11-0601 TPG-Anthony Price: \$8.24	 Bright White pantone Custom Code: 11-0601 TPG-Anthony Price: \$8.24
<b>TRIMS</b>								

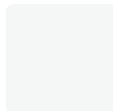
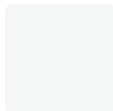
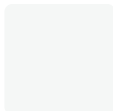



# Tote Bag - Anthony - Style #1712





AM 376 - SP2022, SP2022, 2021-2022

THUMBNAIL	COMPONENT	QTY	PLACEMENT	SUPPLIER	COO	ABUNDANT GREEN-ANTHONY CODE: 18-6026 TPG	BOMBAY BROWN-ANTHONY CODE: 18-1250 TCX	MAROON-ANTHONY.. CODE: 18-1619 TPG
4	 <p><b>Fusible Interfacing- Anthony</b> CODE: asc23 Status : In Development Content (Fiber Content): 100% Polyester Fabric Width: 48" Weight (GSM): 0.31 Finishes: N/A Dye Method: N/A Size: N/A AM 376 - Developer Name: Anthony Sena-Chavez</p>	1 /yd	Used Throughout Bag	To Be Determined	China	 Bright White-Anthony Custom Code: 11-0601 TPG-Anthony Price: \$0.40	 Bright White-Anthony Custom Code: 11-0601 TPG-Anthony Price: \$0.40	 Bright White-Anthony Custom Code: 11-0601 TPG-Anthony Price: \$0.40
5	 <p><b>100% Polyester Thread _</b> CODE: 222 Status : In Development Content (Fiber Content): 100% Polyester Finishes: N/A Dye Method: N/A Size: N/A AM 376 - Developer Name: Anthony Sena-Chavez</p>	1 /Pieces	Used Throughout Bag	To Be Determined	China	 Black 3 C-Anthony Custom Code: Black 3 C-Anthony Price: \$0.38	 Black 3 C-Anthony Custom Code: Black 3 C-Anthony Price: \$0.38	 Black 3 C-Anthony Custom Code: Black 3 C-Anthony Price: \$0.38
6	 <p><b>100% Polyester Zipper- Anthony</b> CODE: efjek Status : In Development Content (Fiber Content): 100% Polyester Finishes: N/A Dye Method: N/A Size: N/A AM 376 - Developer Name: Anthony Sena-Chavez</p>	3 /Pieces	Used as closure for Bag and Zipper Pockets	To Be Determined	China	 Black 3 C-Anthony. Custom Code: Black 3 C Price: \$0.99	 Black 3 C-Anthony. Custom Code: Black 3 C Price: \$0.99	 Black 3 C-Anthony. Custom Code: Black 3 C Price: \$0.99
<b>PACKAGING</b>								

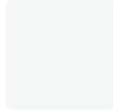
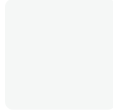
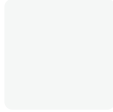

# Tote Bag - Anthony - Style #1712

AM 376 - SP2022, SP2022, 2021-2022

THUMBNAIL	COMPONENT	QTY	PLACEMENT	SUPPLIER	COO	ABUNDANT GREEN-ANTHONY CODE: 18-6026 TPG	BOMBAY BROWN-ANTHONY CODE: 18-1250 TCX	MAROON-ANTHONY.. CODE: 18-1619 TPG
7	 <p><b>Custom Embossed Hangtag</b> CODE: gKjr0 Status : In Development Content (Fiber Content): Paper Weight (GSM): 0.002 Finishes: N/A Dye Method: N/A Size: N/A AM 376 - Developer Name: Anthony Sena</p>	1 /Pieces	Attached to Arm Strap	To Be Determined	China	 Bright White-Anthony Custom Code: 11-0601 TPG-Anthony Price: \$0.15	 Bright White-Anthony Custom Code: 11-0601 TPG-Anthony Price: \$0.15	 Bright White-Anthony Custom Code: 11-0601 TPG-Anthony Price: \$0.15
8	 <p><b>Packaging Box</b> CODE: 2563 Status : In Development Content (Fiber Content): Cardboard Finishes: N/A Dye Method: N/A Size: N/A AM 376 - Developer Name: Anthony Sena</p>	1 /Pieces	N/A	To Be Determined	China	 Black 3 C-Anthony Custom Code: Black 3 C-Anthony Price: \$0.53	 Black 3 C-Anthony Custom Code: Black 3 C-Anthony Price: \$0.53	 Black 3 C-Anthony Custom Code: Black 3 C-Anthony Price: \$0.53
Components 8						Total <b>\$25.67</b>	Total <b>\$25.67</b>	Total <b>\$25.67</b>



**Sample Size: OS**

POINT OF MEASURE	CODE	HOW TO MEASURE	CRITICAL	TYPE	TOLERANCE	OS
Bag Length	XabTx2	Measure from top left edge of bag to bottom left edge of bag	true	Full	1/4 in	14 in
Bag Width	evrre	Measure from top left edge of bag to top right edge of bag	true	Full	1/4 in	17 in
Bag Depth	jwrwr	Measure from center top to bottom center of bag	true	Full	1/4 in	14 in
Zipper Pocket Length	ufh4f	Measure from top right edge of pocket to bottom right edge of pocket	true	Full	1/4 in	6 in
Zipper Pocket Width	ojrfe	Measure from top left edge of pocket to top right edge of pocket	true	Full	1/4 in	6 in
Zipper Pocket Depth	kjsdf	Measure from top center of pocket to bottom center of pocket	true	Full	1/4 in	6 in
Strap Length	wojon	Measure from top left edge of strap to bottom eft edge of strap	true	Full	1/4 in	28 in
Strap Width	jinjnm	Measure from top left edge of strap to top right edge of strap	true	Full	1/4 in	4 in



**Sample Size: OS**

POINT OF MEASURE	CODE	HOW TO MEASURE	CRITICAL	TYPE	TOLERANCE	OS
Bag Length	XabTx2	Measure from top left edge of bag to bottom left edge of bag	true	Full	1/4 in	14 in
Bag Width	evrre	Measure from top left edge of bag to top right edge of bag	true	Full	1/4 in	17 in
Bag Depth	jwrwr	Measure from center top to bottom center of bag	true	Full	1/4 in	14 in
Zipper Pocket Length	ufh4f	Measure from top right edge of pocket to bottom right edge of pocket	true	Full	1/4 in	6 in
Zipper Pocket Width	ojrfe	Measure from top left edge of pocket to top right edge of pocket	true	Full	1/4 in	6 in
Zipper Pocket Depth	kjsdf	Measure from top center of pocket to bottom center of pocket	true	Full	1/4 in	6 in
Strap Length	wojon	Measure from top left edge of strap to bottom eft edge of strap	true	Full	1/4 in	28 in
Strap Width	jinjnm	Measure from top left edge of strap to top right edge of strap	true	Full	1/4 in	4 in